

# NICE F1 3266

66 1/2" x 31 7/8" x 23 1/4" [71 gallons]

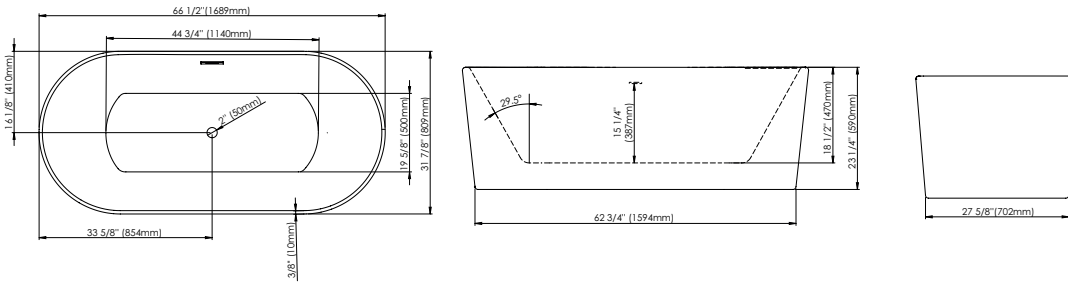

24-48 hrs

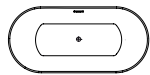

Bathtub only

NIC3266F1

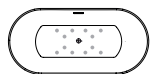

Mass-Air

NIC3266F1M

Included: 12 injectors, 750W (1 1/2h.p.) Optima blower, with 300W heating element, 72" blower hose extension, and remote control.

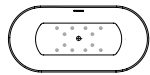

Rouge-Air

NIC3266F1A

Included: 12 micro-jets, 750W (1 1/2h.p.) Optima blower, with 300W heating element, 72" blower hose extension, and remote control.

## GENERAL OPTIONS

Overflow and waste included: Chrome

Above-the-floor rough (AFR)

Acrylic Colour: White

Adjustable feet

Standard

Bathtub drain adapter (picture below)

Gel black neck pillow

White or brushed nickel overflow and drain kit

## MASS-AIR / ROUGE-AIR OPTIONS

Mass-Air Jet finish: White/Chrome

Standard

Others: Chrome/Chrome

96" blower hose extension

A blower hose extension is required when the blower is located more than 4' from the bathtub.

\* Possibility to install FEN990240 and TAR990340 faucets.

## BATHTUB DRAIN ADAPTER

D-111 (123 Connect) is a floor drain adapter designed to facilitate the installation of freestanding bathtubs (must be installed before tiles are laid).

Designed to be installed in a 8" to 10" joist space.

Can be installed with a waterproofing membrane

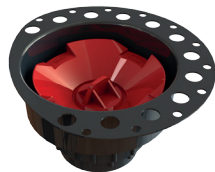

White



Brushed nickel



Chrome

## LINEAR OVERFLOW

**CONFORMITY ATTESTATION**  
Bathtub Standards  
CAN / CSA.B45.5  
Hydromassage Standard  
CAN / CSA.B45.10 / CSA.C22.2 / UL-1795



Intertek



**ECORESPONSABLE Certification**  
First manufacturer of bathroom products in North America to be certified ecoresponsible



  
**Produits Neptune**  
**Rouge**

6635, Picard street, Saint-Hyacinthe (Québec) J2S 1H3  
Phone: (450) 773-7058 - Fax: (450) 773-5063  
produitsneptune.com



Produits Neptune  
Rouge

## Nice F1 3266

Bathtub

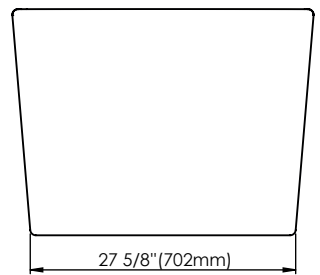
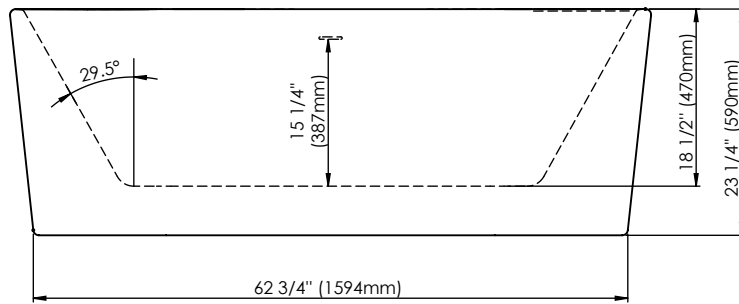
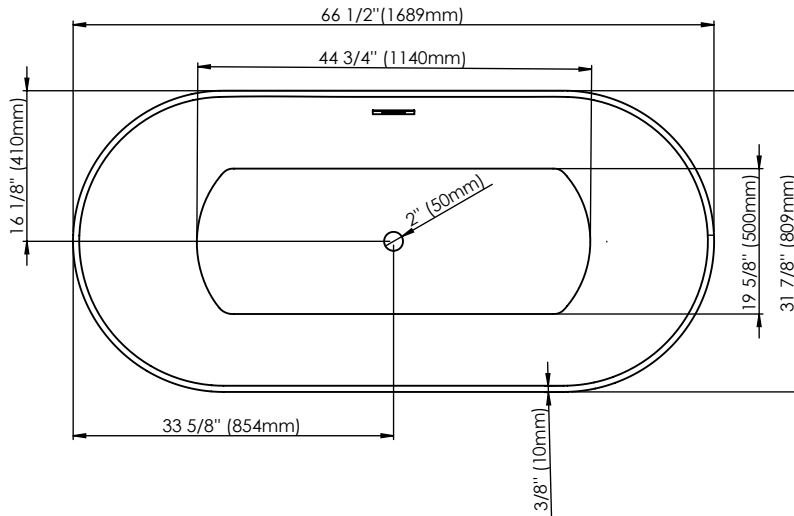

Ajustable feet

Above-the-floor rough (AFR)

\*All dimensions are approximate and subject to change without notice  
Please refer to the installation guide before beginning the installation